

OSPRZĘT DŹWIGOWY DŹWIGU PŁYWAJĄCEGO „MAJA” LIFTING EQUIPEMNT OF FLOATING CRANE „MAJA”

SZAKLE / SHACKLES

	DOR/WLL (ton)	"A" [mm]	"C" [mm]	"B" [mm]	ilość [szt.]
1.	8.5	28	43	95	4
2.	13.5	38	57	133	4
3.	30.0	42	65	165	4 (W)
4.	35.0	57	82.5	197	4
5.	55.0	57	95	250	8 (W)
6.	75.0	70	105	290	6 (W)
7.	125.0	80	130	365	5 (W)
8.	150.0	95	140	390	4 (W)
9.	200.0	105	150	480	4 (W)

(W)- Wide Body Shackles

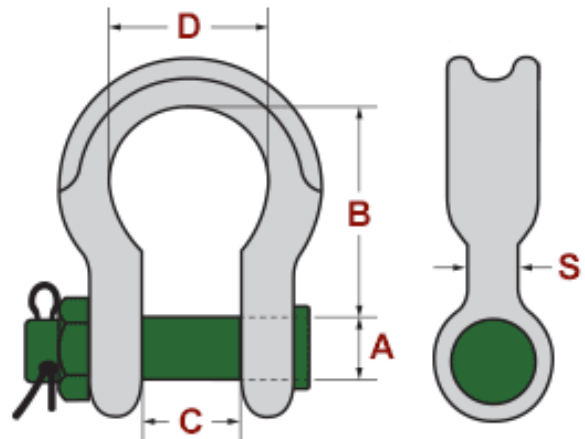

ZAWIESIA / SLINGS

	DOR/WLL (ton)	"L" [m]	wire diam. [mm]	"B" [m]	ilość [szt.]
Slings with soft eye					
1.	8.0	8,0	24	2,0	4
2.	10.0	10,0	32	kausza 3,0	4
3.	20.0	10,0	40	2,0	4
4.	38.0	19,0	52	2,0	2
5.	58.0	20,0	64	2,5	4
6.	65.0	12,0	68	2,5	4
Grommet slings					
7.	50.0	15,0	54	-	4
8.	50.0	22,0	54	-	4
9.	55.0	1,0	60	-	3
10.	60.0	1,0	60	-	1
11.	55.0	2,0	60	-	4
12.	55.0	3,0	60	-	2
13.	60.0	3,0	60	-	2
14.	50.0	4,0	60	-	2
15.	55.0	4,0	60	-	2
16.	55.0	7,0	60	-	5
17.	75.0	17,0	66	-	5
18.	102.0	18,0	78	-	2
19.	158.0	18,0	90	-	4
20.	158.0	20,0	102	-	1
21.	158.0	3,0	90	-	4
22.	158.0	4,0	90	-	2
23.	158.0	5,0	90	-	2
24.	168.0	14,0	96	-	5
25.	168.0	9,0	96	-	4

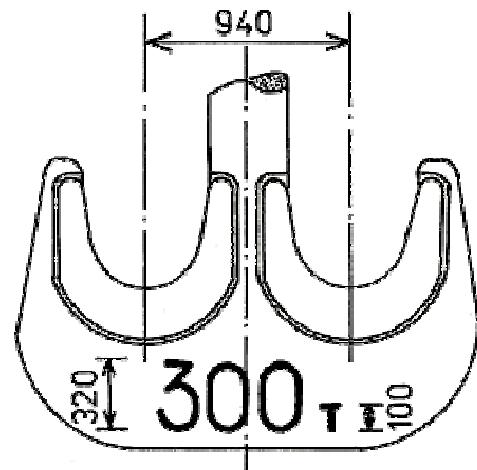
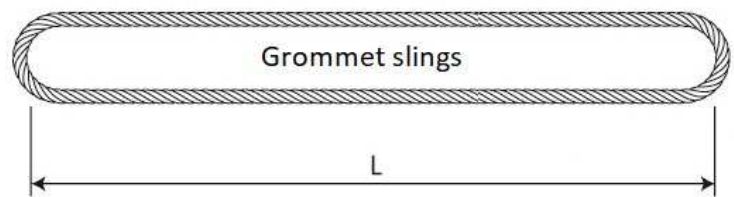
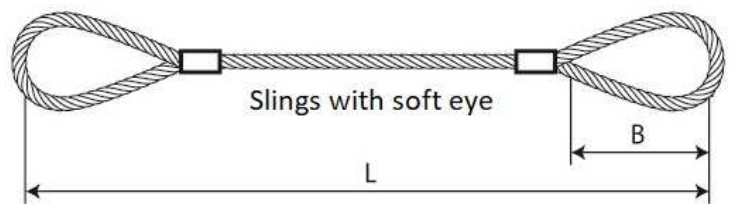

ROZPORNICE

Ilość: **2 sztuki**

DOR pojedynczej: 210 ton
DOR zespołu dwóch rozpornic zawieszonych na jednym haku: 300 ton
długość: od 8 do 12m ze skokiem, co 0,5m

SPREADERS

Amount: **2 pieces**

SWL of single spreader: 210 ton
SWL of set of two lifted by one hook: 300 ton.
Length: from 8 up to 12m with jump of 0,5m

